

# On alternating products of graph relations

R. Bodendiek

Institut f. Mathematik und ihre Didaktik  
Christian-Albrechts-Universität Kiel

R.Lang

Fachbereich Informatik  
Universität Hamburg

## Abstract

It is well-known that one can give an elegant version of the Kuratowski-type theorem for the projective plane by means of the five elementary relations  $R_i, i = 0, 1, \dots, 4$ , on the set  $\Gamma$  of all finite, undirected graphs without loops and multiple edges. Furthermore, these five relations play an interesting role in didactics of mathematics. Following a theory given in [2], C.Thies investigates them in [3]. In order to show that  $R_0, R_1, \dots, R_4$  are an appropriate curriculum he has to deal with so-called alternating products

$$RT(R_i) \circ RT(R_i^{-1}) \circ RT(R_i) \circ RT(R_i^{-1}) \circ \dots$$

or

$$RT(R_i^{-1}) \circ RT(R_i) \circ RT(R_i^{-1}) \circ RT(R_i) \circ \dots,$$

$i = 0, 1, \dots, 4$ , where  $RT(R_i)$  denotes the reflexive transitive closure of  $R_i$  and  $RT(R_i^{-1}) = RT(R_i)^{-1}$  the reflexive, transitive closure of  $R_i^{-1}$ . Here, it is shown that, in case of  $i = 0$ , there exists exactly one alternating product in the set of all alternating products of  $R_0$ , in case of  $i = 3$  and  $i = 4$  the sets of all alternating products of  $R_3$  and  $R_4$  are infinite sets.

# 1 Introduction

In the theory of embedding graphs into orientable and nonorientable surfaces, the five elementary relations  $R_0, R_1, \dots, R_4$ , introduced in [1], play an important role because it is possible to give elegant and precise definitions of the subgraph relation and the subdivision relation and the minor relation on the set  $\Gamma$  of all finite, undirected graphs without loops and multiple edges. Observing that an ordered pair  $(G, H) \in \Gamma \times \Gamma$  belongs to  $R_0$  iff  $H$  arises from  $G$  by removing an edge  $e \in E(G)$  or an isolated vertex  $v \in V(G)$  the subgraph relation is equal to the reflexive, transitive closure  $RT(R_0)$  of  $R_0$ .

An ordered pair  $(G, H) \in \Gamma \times \Gamma$  belongs to  $R_1$  iff  $H$  arises from  $G$  by contracting an edge  $e = \{v, v'\} \in E(G)$ , provided at least one of the two endpoints  $v, v'$  has got degree 1 or 2, and  $v, v'$  do not have a common neighbour in  $G$ . If  $U_1 = R_0 \cup R_1$ , then the well-known subdivision relation is equal to the reflexive, transitive closure  $RT(U_1)$  of  $U_1 = R_0 \cup R_1$ .

To give a precise definition of the famous minor relation on  $\Gamma$  we need  $R_0, R_1$  and  $R_2$ . An ordered pair  $(G, H) \in \Gamma \times \Gamma$  belongs to  $R_2$  iff  $H$  arises from  $G$  by the contraction of an edge  $e = \{v, v'\} \in E(G)$  provided  $v, v'$  do not have a common neighbour in  $G$ , and both  $v$  and  $v'$  have got a degree  $\geq 3$ .

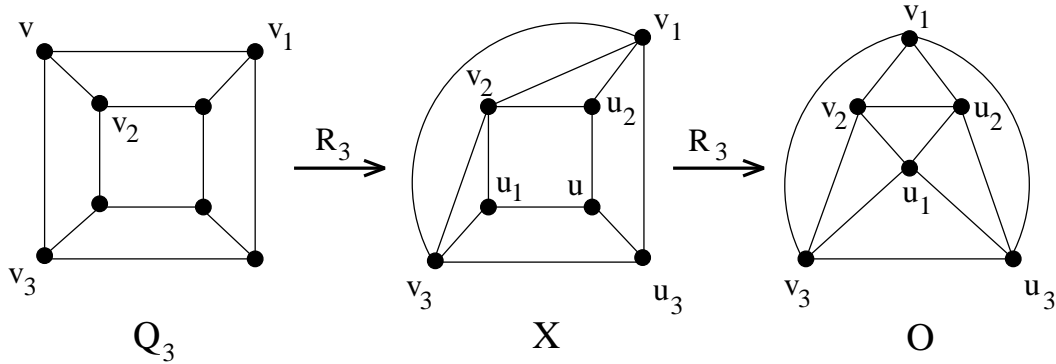

Figure 1:

If  $U_2$  denotes the union  $U_2 = R_0 \cup R_1 \cup R_2$ , then the minor relation on  $\Gamma$  is equal to the reflexive, transitive closure  $RT(U_2)$  of  $U_2 = R_0 \cup R_1 \cup R_2$ .

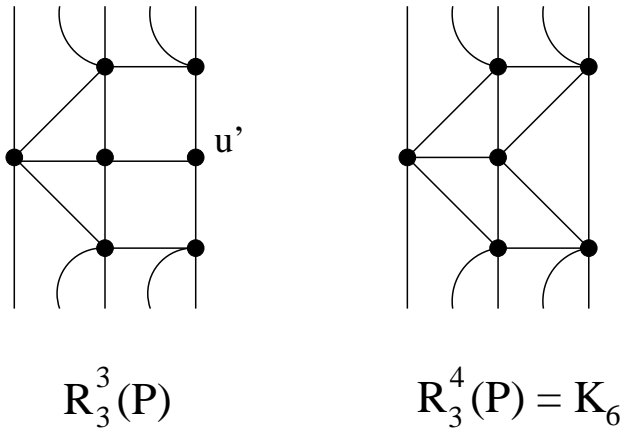
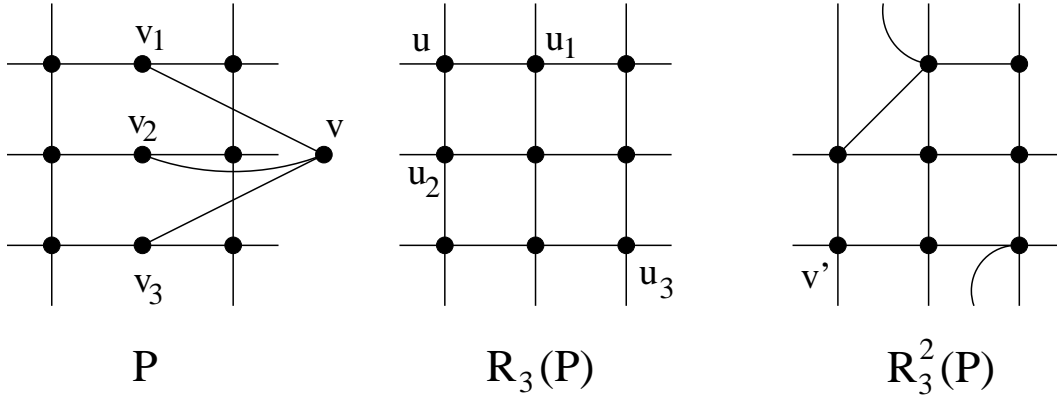

Figure 2:

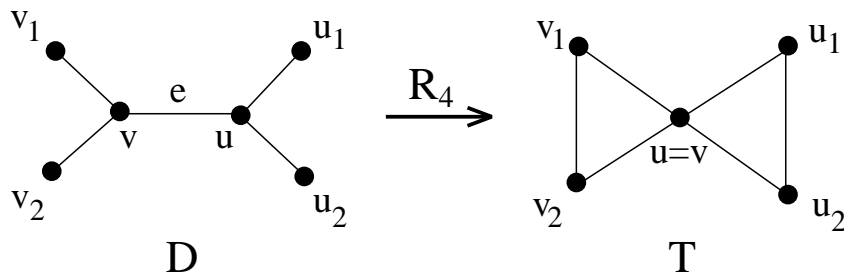

Figure 3:

It is almost superfluous to mention that  $RT(R_0), RT(U_1), RT(U_2)$  are partial ordering relations on  $\Gamma$  while  $R_0, R_1, R_2$  are not partial ordering relations on  $\Gamma$ .

Now, it remains to give the definition of  $R_3$  and  $R_4$ . The great advantage of  $R_3$  and  $R_4$  and their reflexive, transitive closures  $RT(U_3), RT(U_4), U_i = R_0 \cup R_1 \cup \dots \cup R_i, i = 3, 4$ , is that we need essentially less graphs in order to characterize the set of all graphs not embeddable into an orientable or nonorientable surface.

Due to [1], an ordered pair  $(G, H) \in \Gamma \times \Gamma$  belongs to  $R_3$  iff  $H$  arises from  $G$  by substituting a star  $S_3 = \{v\} * \{v_1, v_2, v_3\}, v, v_1, v_2, v_3 \in V(G)$ , by the triangle  $K_3 = (v_1, v_2, v_3)$  provided  $\{v_1, v_2, v_3\}$  is an independent set in  $V$ .

Figure 1 shows that the octahedron  $O$  arises from the cube  $Q_3$  by applying  $R_3$  twice. In other words, we can say that the ordered pair  $(Q_3, O) \in R_3 \circ R_3$ , or equivalently  $(Q_3, O) \in RT(R_3)$ .

Figure 2 shows a representation of the Petersen graph  $P$  and four other graphs  $R_3(P), R_3^2(P), R_3^3(P), R_3^4(P)$  in the projective plane such that it is clear that the ordered pair  $(P, K_6) \in R_3 \circ R_3 \circ R_3 \circ R_3$ , or equivalently  $(P, K_6) \in RT(R_3)$ .

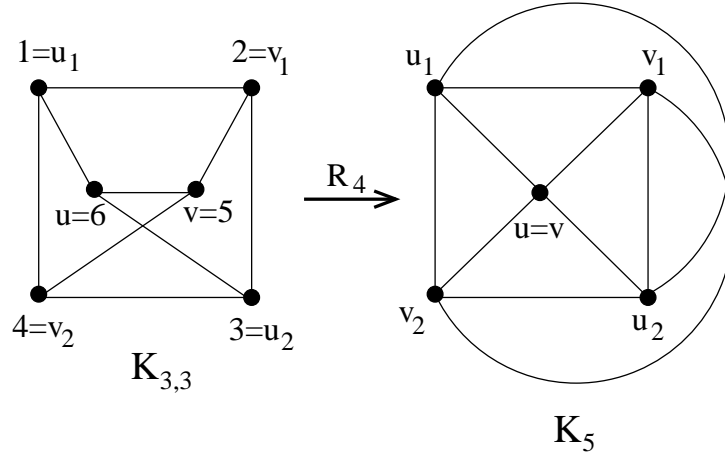

Figure 4:

Due to [1] an ordered pair  $(G, H) \in \Gamma \times \Gamma$  belongs to  $R_4$  iff  $H$  arises from  $G$  by substituting a double star  $D \subseteq G$  by a double triangle  $T$  (Figure 3) provided

the edges  $\{v_1, v_2\}$  and  $\{u_1, u_2\}$  do not belong to  $G$ .

Figure 4 shows the decisive advantage of  $R_4$  because the two Kuratowski graphs  $K_5$  and  $K_{3,3}$  have got the property that the ordered pair  $(K_{3,3}, K_5) \in R_4$ .

## 2 Alternating products

In order to be able to define the concept of an alternating product it makes sense to introduce the converse relations of  $R_i, i = 0, 1, 2, 3, 4$ . Since we are going to restrict ourselves to the converse relations  $R_0^{-1}, R_3^{-1}$  and  $R_4^{-1}$  we omit the definitions of  $R_1^{-1}$  and  $R_2^{-1}$ .

Observing the definitions of  $R_0, R_3$  and  $R_4$  we obtain

a) an ordered pair  $(G, H) \in \Gamma \times \Gamma$  belongs to  $R_0^{-1}$  iff  $H$  arises from  $G$  by adding an edge  $e \in \mathfrak{P}_2(V) - E$  or a new isolated vertex  $v \notin V$ ,

b) an ordered pair  $(G, H) \in \Gamma \times \Gamma$  belongs to  $R_3^{-1}$  iff  $H$  arises from  $G$  by substituting a triangle  $C_3 = (v_1, v_2, v_3)$  by the star  $v * \{v_1, v_2, v_3\}$  such that  $v$  is a new vertex, not belonging to  $G$ ,

c) an ordered pair  $(G, H) \in \Gamma \times \Gamma$  belongs to  $R_4^{-1}$  iff  $H$  arises from  $G$  by substituting a double triangle  $T$  (1-amalgamation of two disjoint triangles) by a double trihedral  $D$  (double star) (Figure 3).

Observing  $RT(R_i^{-1}) = RT(R_i)^{-1}, i = 0, 3, 4$ , we are able to introduce alternating products  $\mathfrak{A}_i(n)$  and  $\mathfrak{B}_i(n), i = 0, 3, 4$ , of  $n \in \mathbb{N}, n \geq 2$ , factors as follows

$$\mathfrak{A}_i(n) = \begin{cases} RT(R_i) \circ RT(R_i)^{-1} \circ \dots \circ RT(R_i) \circ RT(R_i)^{-1} & \text{if } n \equiv 0 \pmod{2}, \\ RT(R_i) \circ RT(R_i)^{-1} \circ \dots \circ RT(R_i)^{-1} \circ RT(R_i) & \text{if } n \equiv 1 \pmod{2}, \end{cases}$$

$$\mathfrak{B}_i(n) = \begin{cases} RT(R_i)^{-1} \circ RT(R_i) \circ \dots \circ RT(R_i)^{-1} \circ RT(R_i) & \text{if } n \equiv 0 \pmod{2}, \\ RT(R_i)^{-1} \circ RT(R_i) \circ \dots \circ RT(R_i) \circ RT(R_i)^{-1} & \text{if } n \equiv 1 \pmod{2}. \end{cases}$$

If we denote the sets of all alternating products of  $R_i, i = 0, 3, 4$ , by  $\mathcal{A}_i$  and  $\mathcal{B}_i$ , defined as follows

$$\mathcal{A}_i = \{\mathfrak{A}_i(n) | n \in \mathbb{N} - \{1\}\}, \mathcal{B}_i = \{\mathfrak{B}_i(n) | n \in \mathbb{N} - \{1\}\}, \quad (1)$$

we are going to investigate the question whether the sets  $\mathcal{A}_i$  and  $\mathcal{B}_i, i = 0, 3, 4$ , are finite or infinite.

### 3 The finiteness of $\mathcal{A}_0$ and $\mathcal{B}_0$

Since first investigations lead to suppose that

$$\mathcal{A}_0 = \{\mathfrak{a}_0(2), \mathfrak{a}_0(3), \mathfrak{a}_0(4), \dots\} \quad (2)$$

and

$$\mathcal{B}_0 = \{\mathfrak{b}_0(2), \mathfrak{b}_0(3), \mathfrak{b}_0(4), \dots\} \quad (3)$$

are finite we first restrict ourselves to  $\mathfrak{a}_0(2)$  and  $\mathfrak{b}_0(2)$ , and prove

#### Theorem 1

$$\begin{aligned} \mathfrak{a}_0(2) = \mathfrak{b}_0(2) = \Gamma \times \Gamma &\iff \\ RT(R_0) \circ RT(R_0)^{-1} = RT(R_0)^{-1} \circ RT(R_0) &= \Gamma \times \Gamma. \end{aligned} \quad (4)$$

**Proof:** Because of  $RT(R_0) \circ RT(R_0)^{-1} \subseteq \Gamma \times \Gamma$  and  $RT(R_0)^{-1} \circ RT(R_0) \subseteq \Gamma \times \Gamma$  it suffices to show the two inclusions (a) and (b) by

$$(a) \quad RT(R_0) \circ RT(R_0)^{-1} \supseteq \Gamma \times \Gamma$$

and

$$(b) \quad RT(R_0)^{-1} \circ RT(R_0) \supseteq \Gamma \times \Gamma.$$

Ad (a) : Observing the definitions of a subset and a composition of relations the inclusion (a) is equivalent to the proposition

$$\bigwedge_{(G,H) \in \Gamma \times \Gamma} \bigvee_{X \in \Gamma} [(G, X) \in RT(R_0) \wedge (X, H) \in RT(R_0)^{-1}]. \quad (5)$$

Assume  $(G, H)$  is any ordered pair in  $\Gamma \times \Gamma$ . As the intersection graph  $G \cap H$  is a subgraph of both  $G$  and  $H$  we obtain  $(G, G \cap H) \in RT(R_0)$  and  $(H, G \cap H) \in RT(R_0)$  such that  $(G \cap H, H) \in RT(R_0)^{-1}$ . Putting  $X = G \cap H$  we obtain  $(G, G \cap H) \in RT(R_0)$  and  $(G \cap H, H) \in RT(R_0)^{-1}$  such that (5) is true. This fact proves the inclusion (a).

Ad (b): Similarly to (a) the inclusion (b) is equivalent to the proposition (6) by

$$\bigwedge_{(G,H) \in \Gamma \times \Gamma} \bigvee_{Y \in \Gamma} [(G, Y) \in RT(R_0)^{-1} \wedge (Y, H) \in RT(R_0)]. \quad (6)$$

The proof of (6) is done by choosing  $Y = G \cup H$  (= union graph of  $G$  and  $H$ ) for any graphs  $G, H \in \Gamma$  for  $G$  and  $H$  are subgraphs of  $Y = G \cup H$  implying  $(G \cup H, G) \in RT(R_0), (G \cup H, H) \in RT(R_0)$  and  $(G, G \cup H) \in RT(R_0)^{-1}$ . This proves (b).

The answer of the question asked above concerning the finiteness of  $\mathcal{A}_0$  and  $\mathcal{B}_0$  is an immediate consequence of theorem 1 and says as follows

**Theorem 2**  $\mathcal{A}_0$  and  $\mathcal{B}_0$  are equal, finite sets and consist of exactly one element  $x = \Gamma \times \Gamma$ , i.e.  $\mathcal{A}_0 = \mathcal{B}_0 = \{\Gamma \times \Gamma\}$ .

**Proof:** Observing Theorem 1 and the fact that the composition of relations on the sets of all relations on  $\Gamma$  is an associative binary operation, the statement of Theorem 2 has been proved iff the two inclusions (7) and (8) by

$$\Gamma \times \Gamma \subseteq (\Gamma \times \Gamma) \circ RT(R_0) \quad (7)$$

and

$$\Gamma \times \Gamma \subseteq (\Gamma \times \Gamma) \circ RT(R_0)^{-1} \quad (8)$$

are true. It is obvious that (7) is true iff the statement

$$\bigwedge_{(G,H) \in \Gamma \times \Gamma} \bigvee_{X \in \Gamma} [(G, X) \in \Gamma \times \Gamma \wedge (X, H) \in RT(R_0)] \quad (9)$$

holds. Choosing  $X = H$  for any  $(G, H) \in \Gamma \times \Gamma$  we recognize immediately that (7) is true.

The proof of (8) is quite the same as the one of (7) such that we are allowed to omit details. This proves Theorem 2.

After this beautiful proof we are going to turn to  $\mathcal{A}_3$  and  $\mathcal{B}_3$  and want to investigate the question whether these two sets are also finite.

## 4 The infinity of $\mathcal{A}_3$ and $\mathcal{B}_3$

Figure 5 shows the five graphs  $G, G_1, G_2, G_3$  and  $H$  that can be characterized by means of  $R_3$  and  $R_3^{-1}$  represented in Figure 6. It shows that the ordered pair  $(G, H)$  belongs to  $\mathfrak{a}_3(4) = RT(R_3) \circ RT(R_3)^{-1} \circ RT(R_3) \circ RT(R_3)^{-1}$

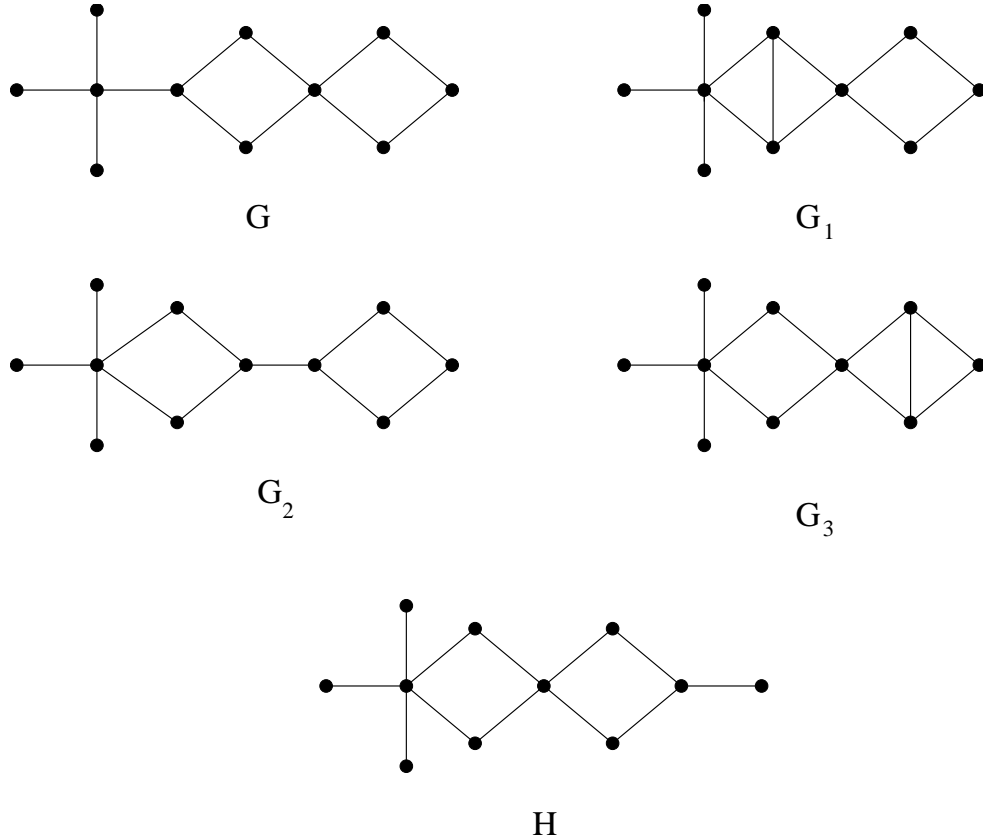

Figure 5:

but it is neither an element of  $\mathfrak{A}_3(3)$  nor of  $\mathfrak{A}_3(2)$ . This fact implies that  $\mathfrak{A}_3(4) \neq \mathfrak{A}_3(i), i = 2, 3$ .

Therefore, it is obvious that  $\mathcal{A}_3$  has at least the three elements  $\mathfrak{A}_3(2), \mathfrak{A}_3(3)$  and  $\mathfrak{A}_3(4)$ .

This fact implies that the situation of  $\mathcal{A}_3$  and  $\mathcal{B}_3$  is quite different from the situation of  $\mathcal{A}_0$  and  $\mathcal{B}_0$  such that we suppose that  $\mathcal{A}_3$  and  $\mathcal{B}_3$  are even infinite sets. In order to give a proof of this assumption we generalize the example of figure 5 and prove

**Theorem 3**  $\mathcal{A}_3$  and  $\mathcal{B}_3$  are infinite sets.

**Proof:** (1) In order to show that  $\mathcal{A}_3$  is infinite we suppose to argue by con-



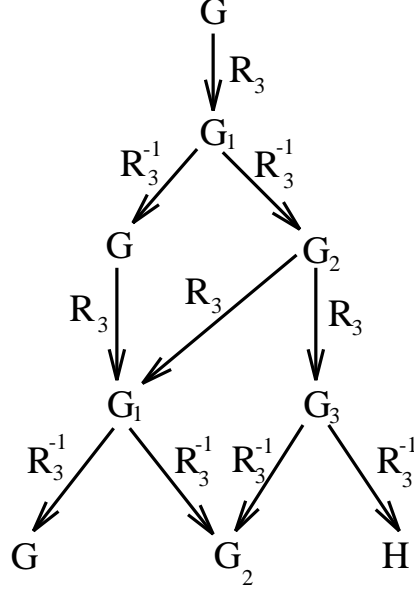

Figure 6:

tradiction that  $\mathcal{A}_3$  is finite. Then there necessarily exists a natural number  $n \in \mathbb{N}, n \geq 3$ , such that  $\mathcal{A}_3 = \{\mathfrak{a}_3(2), \mathfrak{a}_3(4), \dots, \mathfrak{a}_3(n-1)\}$  with the property that there is an element  $k \in \{2, 3, \dots, n-1\}$  for which the equality  $\mathfrak{a}_3(k) = \mathfrak{a}_3(n)$  holds. This is a contradiction to statement (10) by

$$\bigwedge_{i \in \{2, 3, \dots, n-1\}} \mathfrak{a}_3(n) \not\subseteq \mathfrak{a}_3(i). \quad (10)$$

In order to show that (10) is true we argue as follows. (10) is obviously shown, if and only if, we give an ordered pair  $(G, H) \in \mathfrak{a}_3(n)$  not belonging to  $\mathfrak{a}_3(i)$  for any  $i \in \{2, 3, \dots, n-1\}$ . It turns out that it is even possible to show that there is an ordered pair  $(G, H) \in \mathfrak{a}_3(n)$  not belonging to  $\mathfrak{a}_3(i)$  for every  $i \in \{2, 3, \dots, n-1\}$ . If  $n = 2k, k \geq 1$ , is even then we generalize the graph  $G$  from Figure 5. Thus we consider the graphs  $G = G(k)$  and  $H = G_n$  depicted in Figure 7. Generalizing the diagram of Figure 6 we recognize that the ordered pair  $(G, H) = (G(k), G_n)$  is an element of

$$\mathfrak{a}_3(n) = RT(R_3) \circ RT(R_3)^{-1} \circ \dots \circ RT(R_3) \circ RT(R_3)^{-1} \quad (11)$$

but

$$(G, H) = (G(k), G_n) \notin \mathfrak{a}_3(i)$$

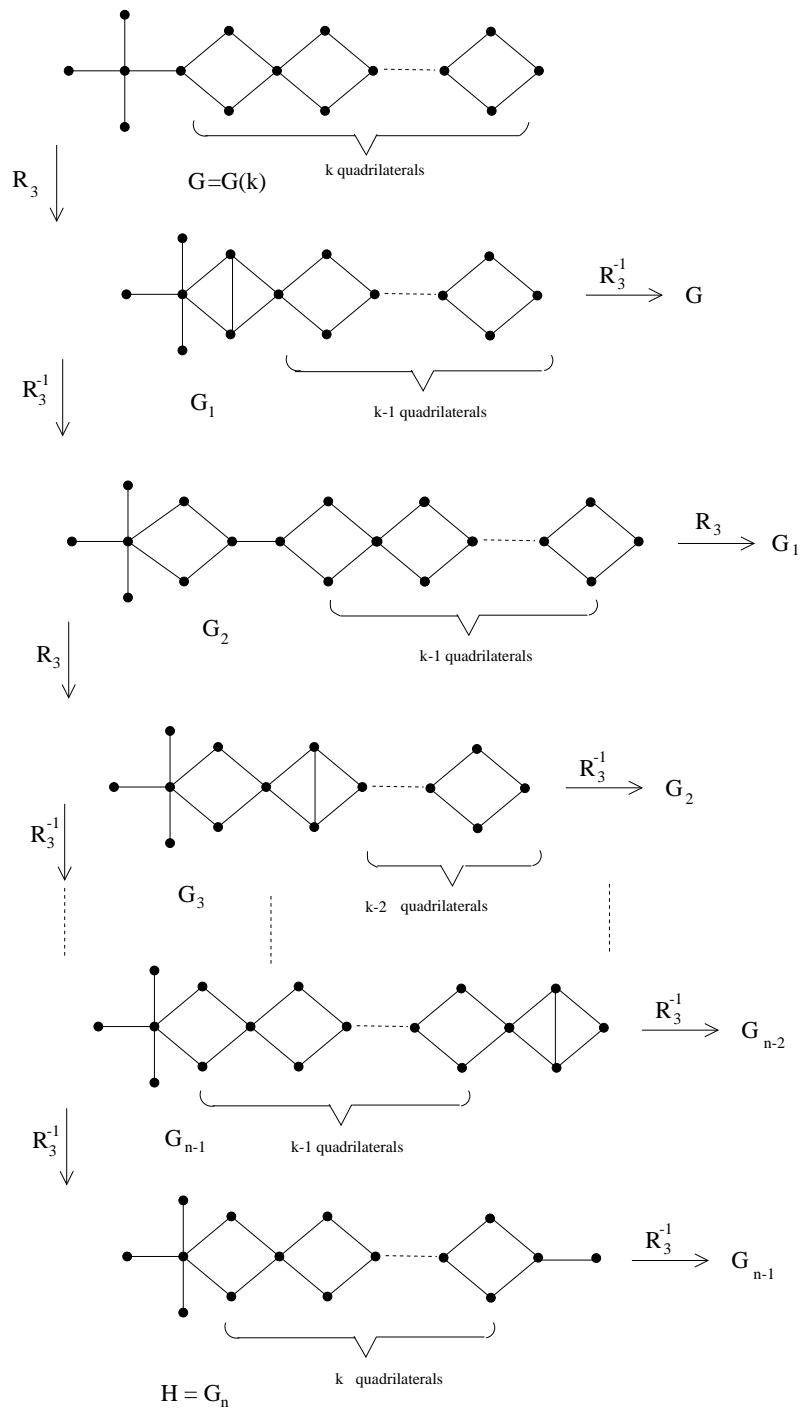

Figure 7:

for each  $i = 2, 3, \dots, n - 1$ .

Since the proof of these two statements is a matter of routine checking, we are allowed to omit details. In the case of odd  $n = 2k + 1, k \geq 1$ , we can argue by observing Figure 8 and choosing  $(G, H) = (G'(k), G'_n)$ . A routine checking shows that  $(G, H) \in \mathfrak{A}_3(n)$ , but  $(G, H) \notin \mathfrak{A}_3(i)$  for each  $i = 2, 3, \dots, n - 1$ . After all, (10) is proved. This implies that our assumption is false and  $\mathcal{A}_3$  is infinite.

(2) To argue by contradiction we assume that  $\mathcal{B}_3$  is finite. Then there exists an integer  $n \geq 3$  such that  $\mathcal{B}_3 = \{\mathfrak{B}_3(2), \mathfrak{B}_3(3), \dots, \mathfrak{B}_3(n - 1)\}$  with the property that there is an element  $k \in \{2, 3, \dots, n - 1\}$  for which  $\mathfrak{A}_3(n)$  is equal to  $\mathfrak{A}_3(k)$ . This equality is a contradiction to statement (12) by

$$\bigwedge_{i \in \{2, 3, \dots, n-1\}} \mathfrak{B}_3(n) \not\subseteq \mathfrak{B}_3(i). \quad (12)$$

We prove (12) by showing the existence of an ordered pair  $(G, H) \in \mathfrak{B}_3(n)$  not belonging to  $\mathfrak{B}_3(i)$  for every  $i \in \{2, 3, \dots, n - 1\}$ .

It is useful to distinguish the two cases

- (a)  $n \equiv 0 \pmod{2}$  and
- (b)  $n \equiv 1 \pmod{2}$ .

In (a) we take  $G = X(k), n = 2k + 2, k \geq 1, k = \frac{n-2}{2}$  and  $H = X_{2k}$  represented in Figure 9. Observing Figure 9 the proof of  $(G, H) \in \mathfrak{B}_3(n)$  and  $(G, H) \notin \mathfrak{B}_3(i)$  for each  $i = 2, 3, \dots, n - 1$  is a matter of routine checking.

In case (b),  $n$  is odd such that  $n = 2k + 1, k \geq 1$ . Then we choose for  $G, H$  the graphs  $Y(k)$  and  $Y_{2k+1}$  depicted in Figure 10. It is easy to see that  $(G, H) \in \mathfrak{B}_3(n)$  and  $(G, H) \notin \mathfrak{B}_3(i)$  for each  $i = 2, 3, \dots, n - 1$ . Hence, the assumption is not true. That means that  $\mathcal{B}_3$  is infinite.

## 5 The infinity of $\mathcal{A}_4$ and $\mathcal{B}_4$

In this section we turn toward the elementary relation  $R_1$ . After having seen that  $\mathcal{A}_3$  and  $\mathcal{B}_3$  are infinite sets it is not difficult to guess that  $\mathcal{A}_4$  and  $\mathcal{B}_4$  are also infinite sets. The confirmation of this guess is given in

**Theorem 4**  $\mathcal{A}_4$  and  $\mathcal{B}_4$  are infinite sets.

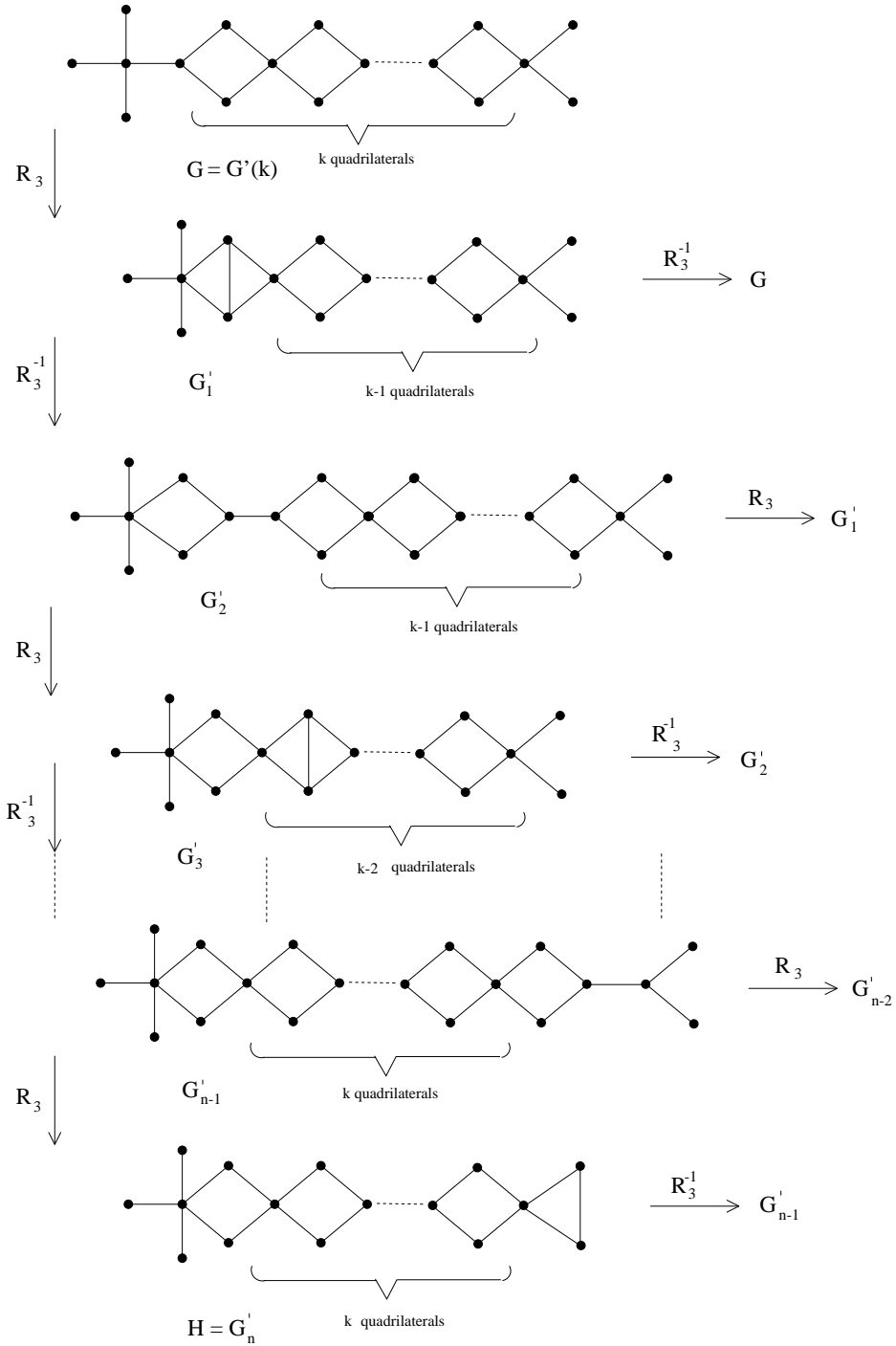

Figure 8:

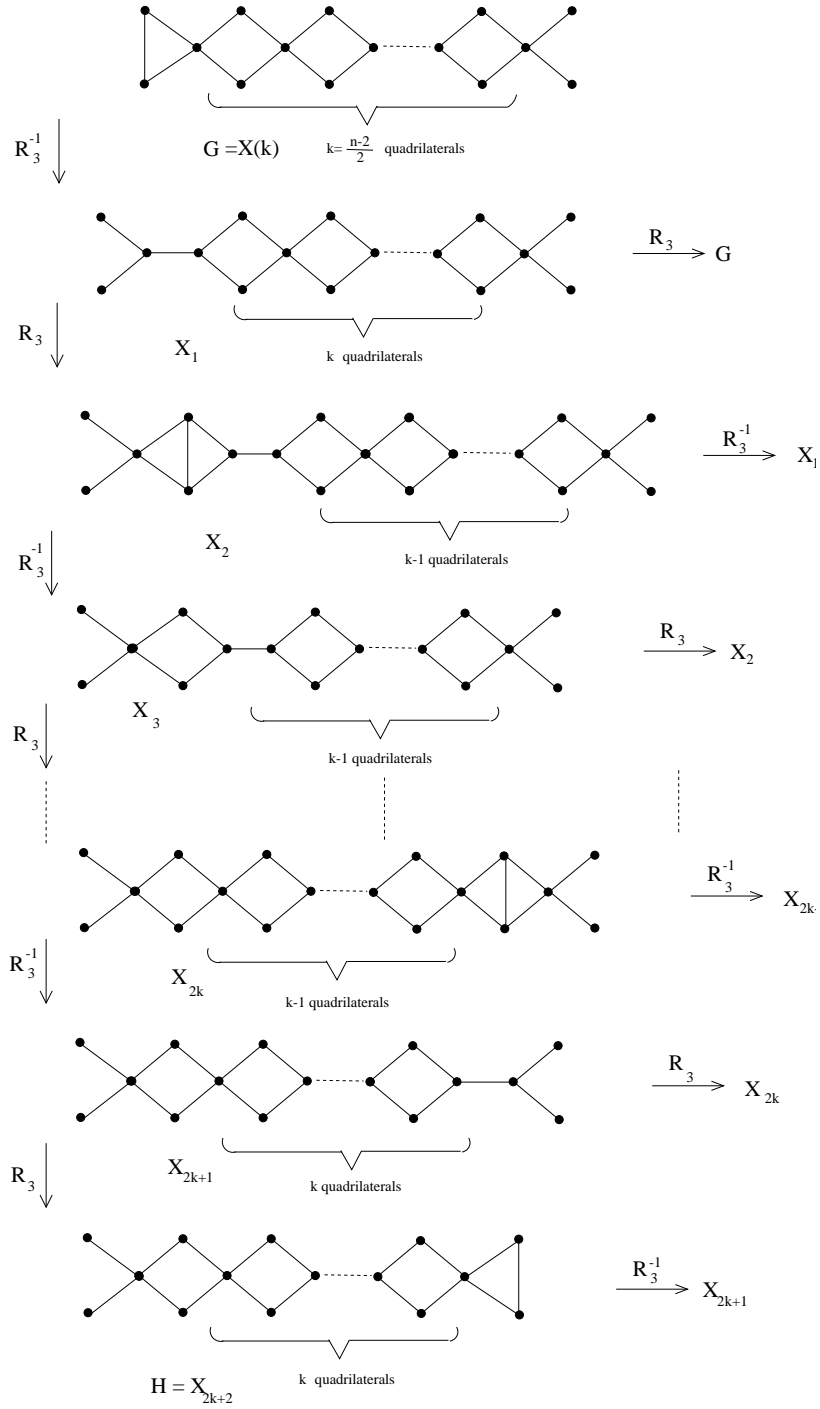

Figure 9:

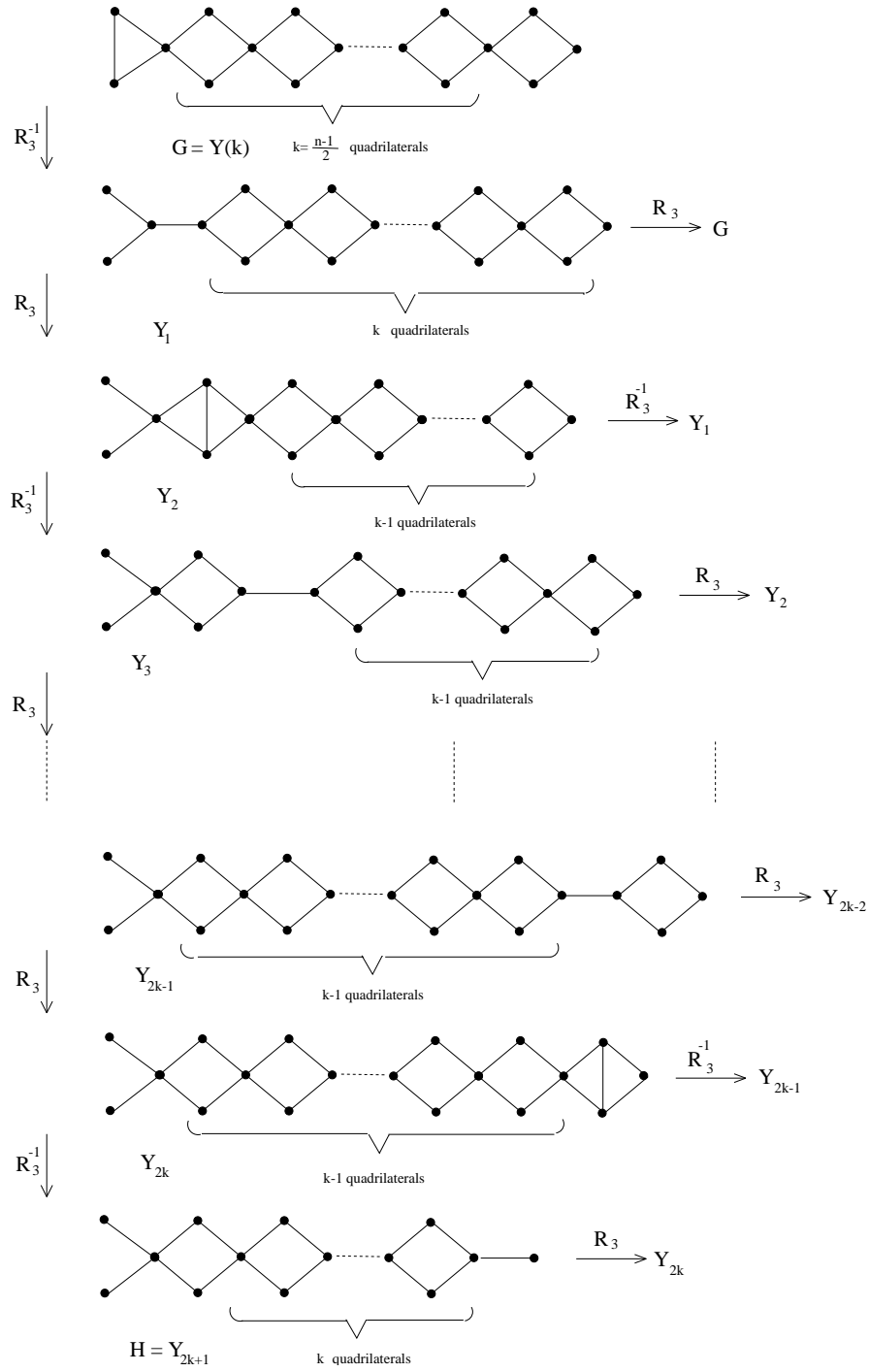

Figure 10:

**Proof:** (1) It is evident that the main idea of this proof is similar to the idea of the proof of (1) in Theorem 3. Therefore, we omit details and restrict ourselves to the proof of statement (13) by

$$\bigwedge_{i \in \{2,3,\dots,n-1\}} \mathfrak{A}_4(n) \not\subseteq \mathfrak{A}_4(i), \quad (13)$$

where  $n$  is assumed to be a positive integer  $\geq 3$  with the property that  $\mathcal{A}_4$  consists of the elements  $\mathfrak{A}_4(2), \mathfrak{A}_4(3), \dots, \mathfrak{A}_4(n-1)$ . In order to find an ordered pair  $(G, H) \in \mathfrak{A}_4(n)$  not belonging to each  $\mathfrak{A}_4(i), i = 2, 3, \dots, n-1$ , we distinguish the two cases  $n \equiv 0 \pmod{2}$  and  $n \equiv 1 \pmod{2}$ . In the first case  $n \equiv 0 \pmod{2}$ , Figure 11 shows the graphs  $G = G(n)$  and  $H = G_n$  satisfying the properties mentioned above. The proof is not quite easy. In spite of this fact we cannot deal with details. In the second case  $n \equiv 1 \pmod{2}$ , Figure 12 depicts the corresponding graphs  $G = H(n)$  and  $H = H_n$ . It is clear by means of Figure 12 that  $(G, H) \in \mathfrak{A}_4(n)$  and  $(G, H) \notin \mathfrak{A}_4(i)$  for each  $i = 2, 3, \dots, n-1$  are true. This completes the proof of (1).

Now we conclude by giving a sketch of the proof of (2), where (2) says that  $\mathfrak{B}_4$  is infinite. Having assumed that  $\mathcal{B}_4$  is finite we have to prove the statement

$$\bigwedge_{i \in \{2,3,\dots,n-1\}} \mathfrak{B}_4(n) \not\subseteq \mathfrak{B}_4(i). \quad (14)$$

by giving an ordered pair  $(G, H) \in \mathfrak{B}_4(n)$  not belonging to each  $\mathfrak{B}_4(i), i = 2, 3, \dots, n-1$ , where  $n$  is chosen as explained above. If  $n \equiv 0 \pmod{2}$  Figure 13 proves that (14) is true for even  $n$  and  $G = X(n)$  and  $H = X_n$ .

If  $n \equiv 1 \pmod{2}$  we choose  $G = Y(n)$  and  $H = Y_n$ . Figure 14 shows that  $(G, H) \in \mathfrak{B}_4(n)$  and  $(G, H) \notin \mathfrak{B}_4(i)$  for each  $i = 2, 3, \dots, n-1$ . This completes the proof in the case (2). That means that  $\mathcal{B}_4$  is infinite.

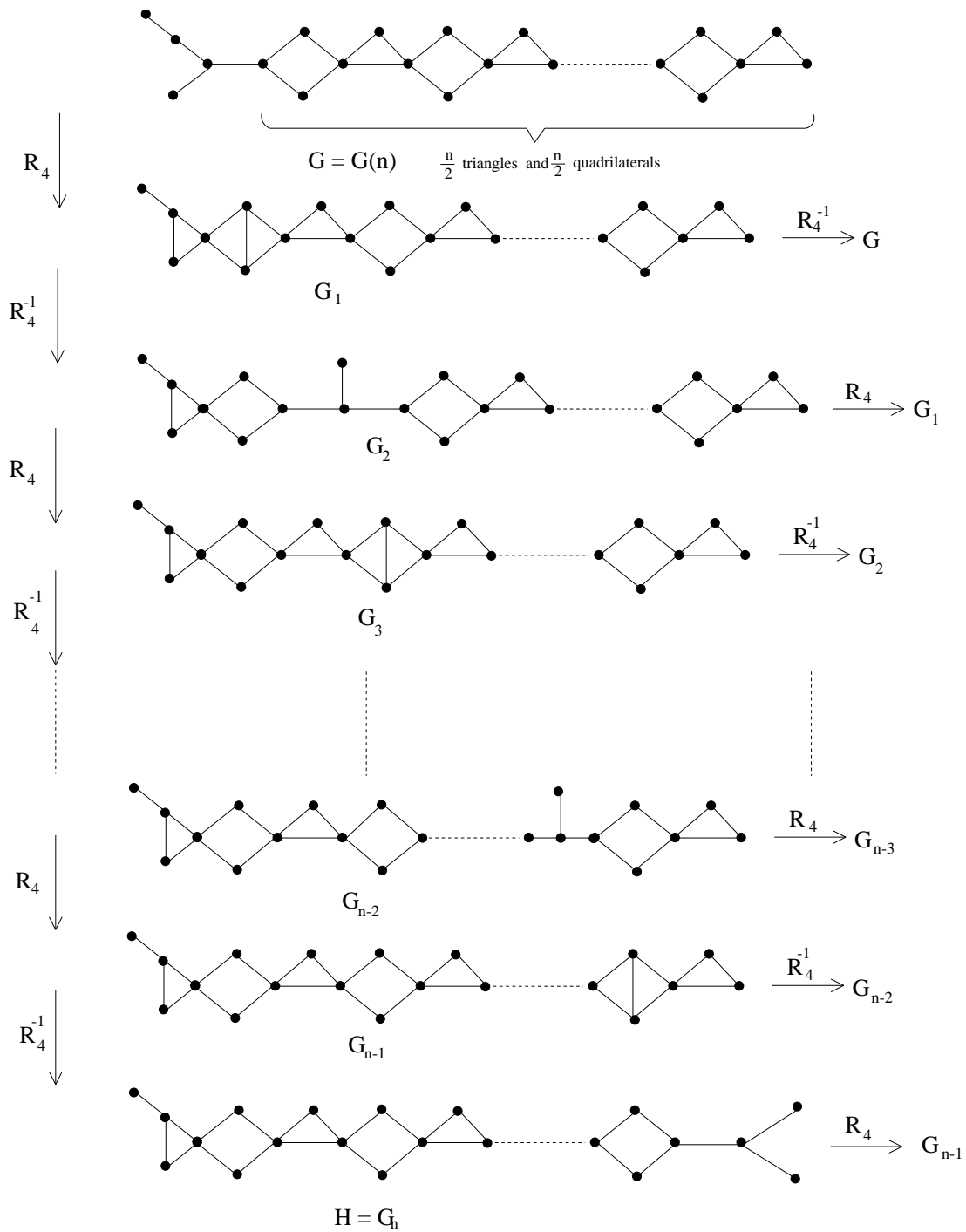

Figure 11:



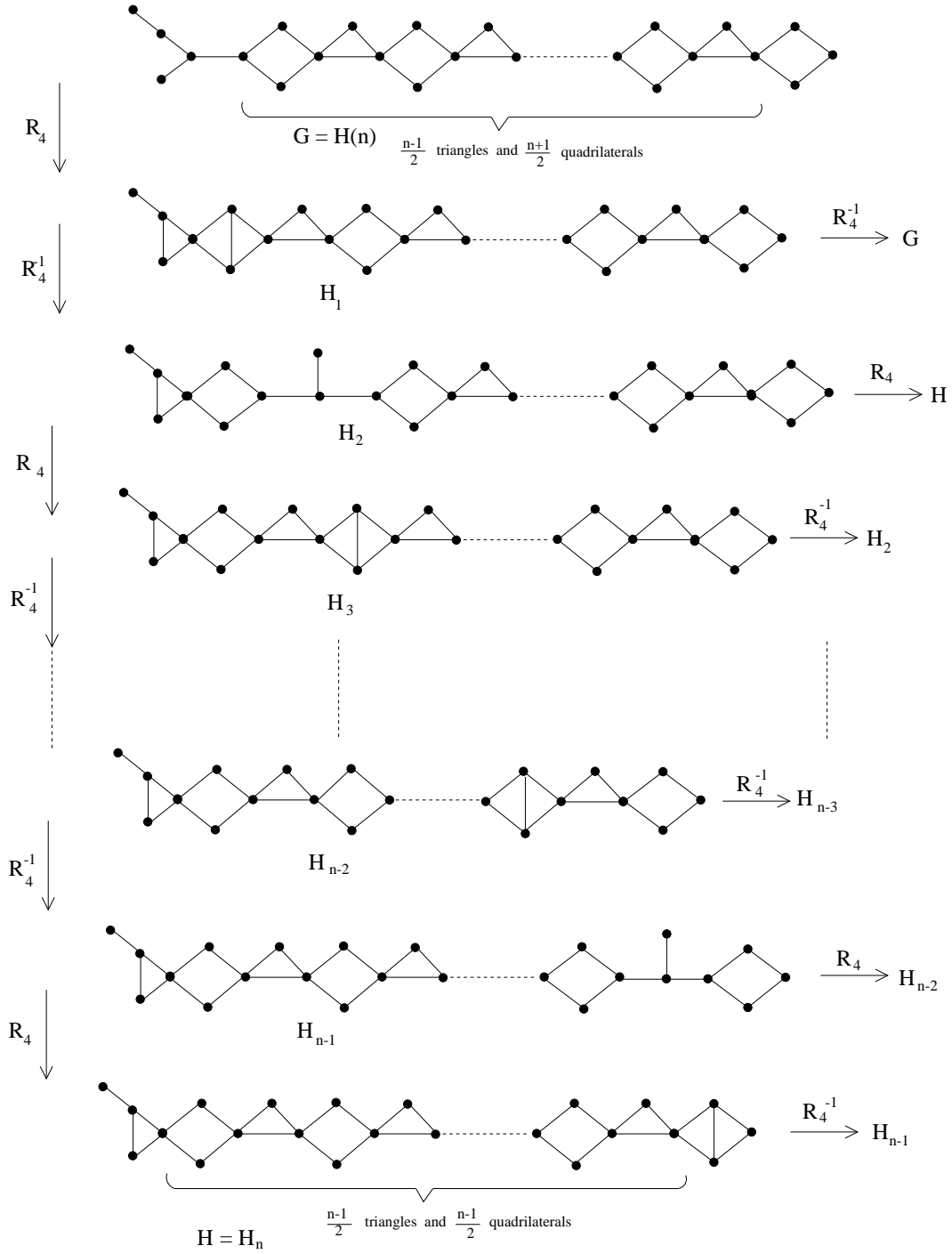

Figure 12:

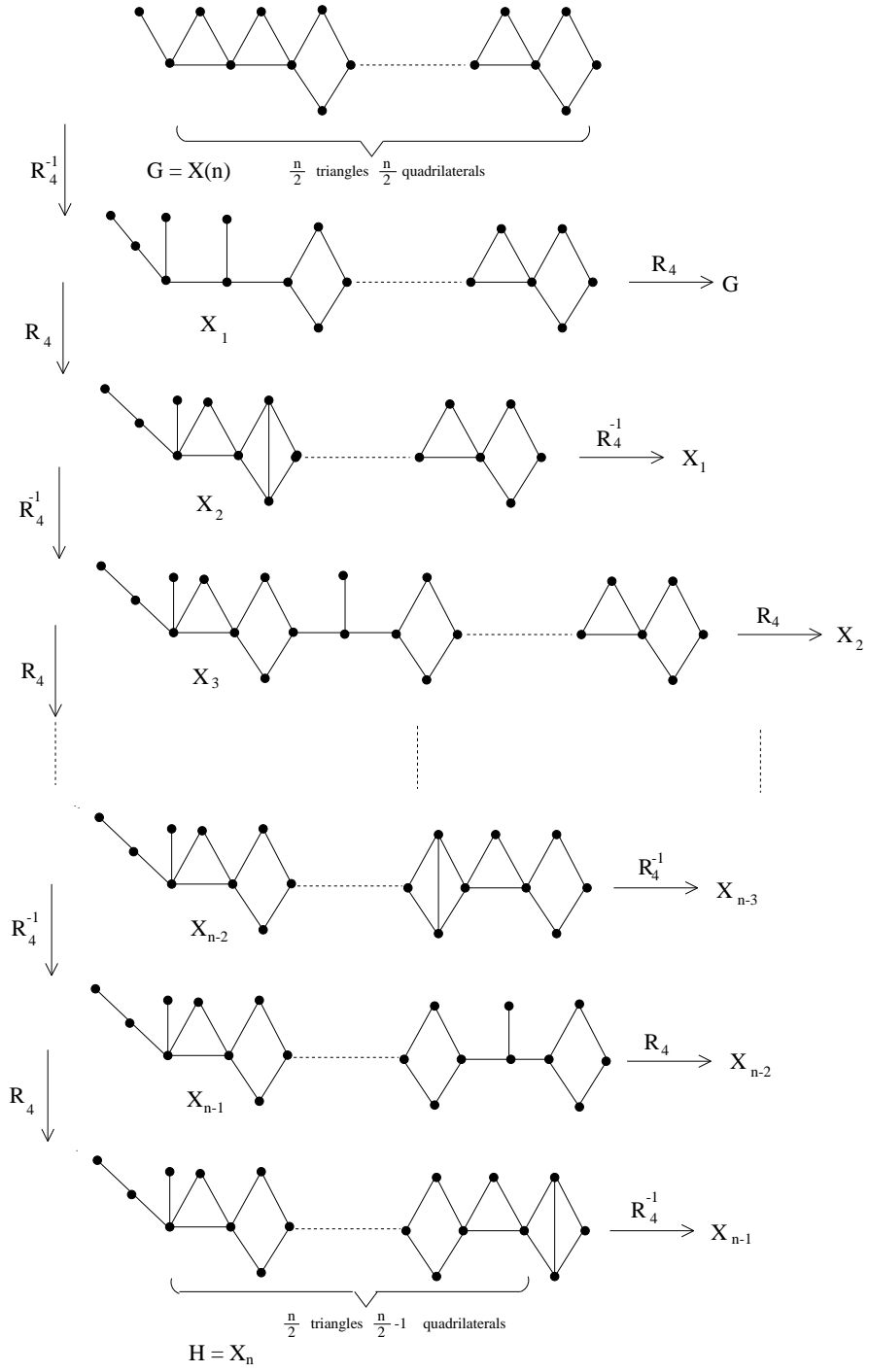

Figure 13:

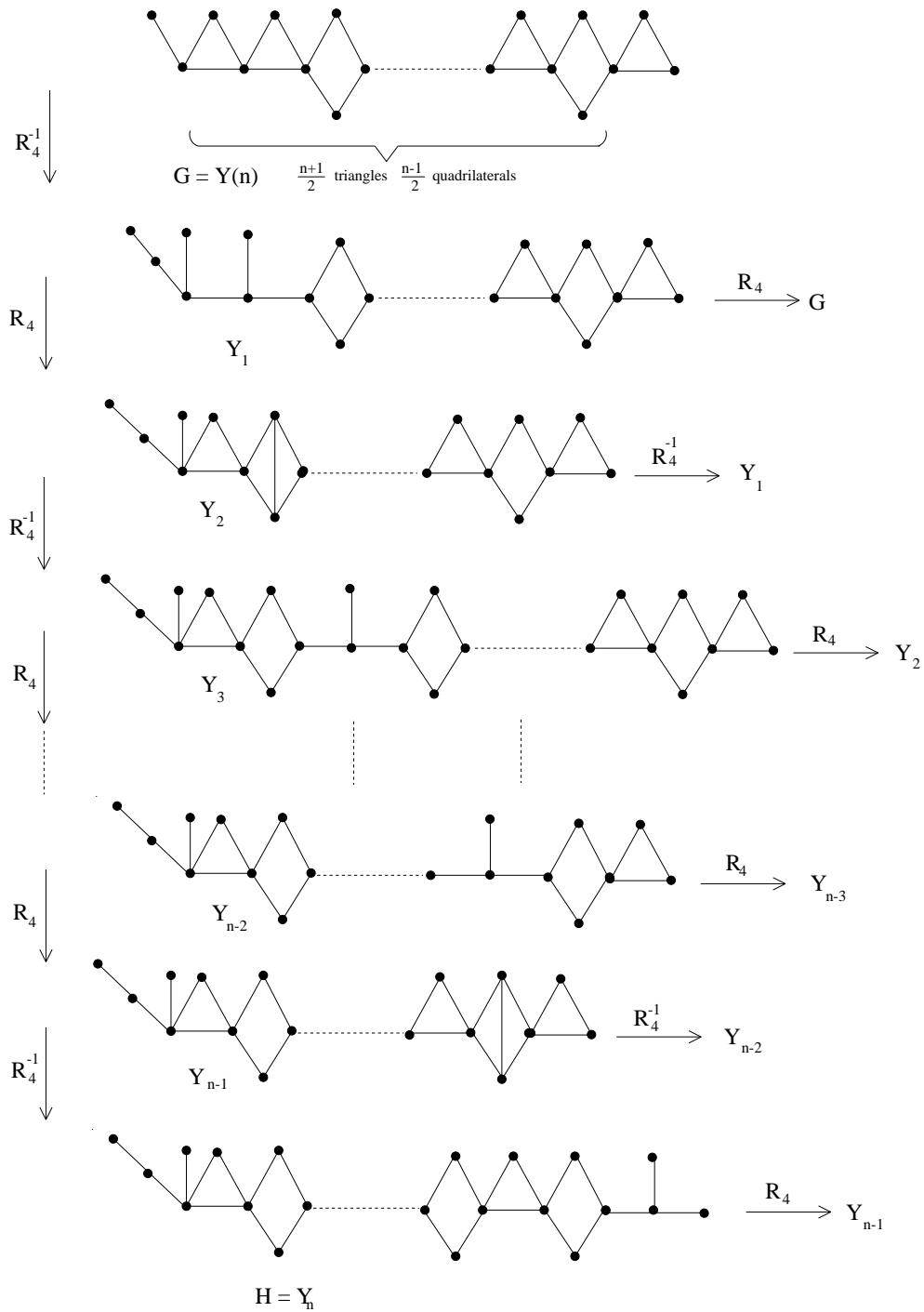

Figure 14:

## References

- [1] R.Bodendiek, H.Schumacher, K.Wagner. *Über Relationen auf Graphenmengen*. Abhandlungen aus dem mathematischen Seminar der Universität Hamburg **51**, 1981.
- [2] D.Sawada. *An assessment of a selected set of Piagetian-derived operators for the generation of effective learning hierarchies*. JRME 1973.
- [3] C.Thies. *Zur Formalisierung des Piagetschen Gruppierungsbegriffs unter besonderer Berücksichtigung graphentheoretischer Relationen*. Dissertation Kiel, 1983.
- [4] K.Wagner, R.Bodendiek. *Graphentheorie I*, BI-Wissenschaftsverlag Mannheim 1989.
- [5] K.Wagner, R.Bodendiek. *Graphentheorie II*, BI-Wissenschaftsverlag Mannheim 1990.
- [6] K.Wagner, R.Bodendiek. *Graphentheorie III*, BI-Wissenschaftsverlag Mannheim 1992.