

A combinatorial Schur expansion of triangle-free horizontal-strip LLT polynomials

Foster Tom*¹

¹*University of California, Berkeley*

Abstract. In recent years, Alexandersson and others proved combinatorial formulas for the Schur function expansion of the horizontal-strip LLT polynomial $G_\lambda(x; q)$ in some special cases. We associate a weighted graph Π to λ and we use it to express a linear relation among LLT polynomials. We apply this relation to prove an explicit combinatorial Schur-positive expansion of $G_\lambda(x; q)$ whenever Π is triangle-free. We also prove that the largest power of q in the LLT polynomial is the total edge weight of our graph.

Keywords: cocharge, Hall–Littlewood polynomial, jeu de taquin, LLT polynomial, Schur-positive, symmetric function

1 Introduction

LLT polynomials are remarkable symmetric functions with many connections in algebraic combinatorics. Lascoux, Leclerc, and Thibon [9] originally defined LLT polynomials in terms of ribbon tableaux in order to study Fock space representations of the quantum affine algebra. Haglund, Haiman, Loehr, Remmel, and Ulyanov [7] redefined them in terms of tuples of skew shapes in their study of diagonal coinvariants. Haglund, Haiman, and Loehr [6] found a combinatorial formula for Macdonald polynomials, which implies a positive expansion in terms of these LLT polynomials $G_\lambda(x; q)$. LLT polynomials are also closely connected to chromatic quasisymmetric functions and to the Frobenius series of the space of diagonal harmonics. Grojnowski and Haiman [5] proved that LLT polynomials, and therefore Macdonald polynomials, are Schur-positive using Kazhdan–Lusztig theory, but it remains a major open problem to find an explicit combinatorial Schur-positive expansion. We give a brief account of some recent results in this direction.

In the unicellular case, meaning that every skew shape of λ consists of a single cell, we can associate a unit interval graph to λ . Huh, Nam, and Yoo [8] found an explicit

*The author was supported in part by the Natural Sciences and Engineering Research Council of Canada.

Schur-positive expansion whenever this graph is a melting lollipop, namely

$$G_\lambda(\mathbf{x}; q) = \sum_{T \in \text{SYT}_n} q^{\text{wt}_a(T)} s_{\text{shape}(T)}. \quad (1.1)$$

Moreover, they proved that for arbitrary unit interval graphs, this formula gives the correct coefficient of s_μ whenever the partition μ is a hook.

More generally, we focus on the horizontal-strip case, meaning that every skew shape of λ is a row. Grojnowski and Haiman [5] showed that if the rows of λ are nested, then $G_\lambda(\mathbf{x}; q)$ is a transformed modified Hall–Littlewood polynomial and so its Schur expansion is given by the celebrated Lascoux–Schützenberger cocharge formula [10], namely

$$G_\lambda(\mathbf{x}; q) = \tilde{H}_\lambda(\mathbf{x}; q) = \sum_{T \in \text{SSYT}(\lambda)} q^{\text{cocharge}(T)} s_{\text{shape}(T)}. \quad (1.2)$$

Alexandersson and Uhlin [3] found a generalization of cocharge to prove an analogous formula when the rows of λ come from a skew shape σ/τ with no column having more than two cells. They formulated it for vertical-strips but we can equivalently state it as

$$G_\lambda(\mathbf{x}; q) = \sum_{T \in \text{SSYT}(\alpha)} q^{\text{cocharge}_\tau(T)} s_{\text{shape}(T)}. \quad (1.3)$$

D’Adderio [4] used recurrences in terms of Schröder paths to prove that the shifted vertical-strip LLT polynomial $G_\lambda(\mathbf{x}; q + 1)$ is a positive linear combination of elementary symmetric functions. Alexandersson conjectured [1] and then proved with Sulzgruber [2] the explicit combinatorial formula

$$G_\lambda(\mathbf{x}; q + 1) = \sum_{\theta \in \mathcal{O}(P)} q^{\text{asc}(\theta)} e_{\lambda(\theta)} \quad (1.4)$$

in terms of acyclic orientations of a decorated unit interval graph associated to λ .

In this extended abstract, we define a *weighted graph* Π associated to λ . In Section 3, we use our weighted graph to express linear recurrences of horizontal-strip LLT polynomials. We further generalize cocharge and apply our recurrences in Section 4 to prove the explicit combinatorial Schur-positive formula

$$G_\lambda(\mathbf{x}; q) = \sum_{T \in \text{SSYT}(\alpha)} q^{\text{cocharge}_\Pi(T)} s_{\text{shape}(T)} \quad (1.5)$$

whenever the weighted graph Π is triangle-free. We also prove that the largest power of q in the LLT polynomial $G_\lambda(\mathbf{x}; q)$ is the total edge weight of Π .

2 Background

A *partition* σ is a finite sequence of nonincreasing positive integers $\sigma = \sigma_1 \cdots \sigma_\ell$. By convention, we set $\sigma_i = 0$ if $i > \ell$. A *skew diagram* λ is a subset of $\mathbb{Z} \times \mathbb{Z}$ of the form

$$\lambda = \sigma/\tau = \{(i, j) : i \geq 1, \tau_i + 1 \leq j \leq \sigma_i\} \quad (2.1)$$

for some partitions σ and τ with $\sigma_i \geq \tau_i$ for every i . When τ is empty, we write σ instead of σ/\emptyset . The elements of λ are called *cells* and the *content* of a cell $u = (i, j) \in \lambda$ is the integer $c(u) = j - i$. We will focus heavily on *rows*, which are skew diagrams of the form

$$R = a/b = \{(1, j) : b + 1 \leq j \leq a\} \quad (2.2)$$

for some $a \geq b \geq 0$. We denote by $\ell(R) = b$ and $r(R) = a - 1$ the smallest and largest contents of cells in R respectively. A *semistandard Young tableau (SSYT)* of shape λ is a function $T : \lambda \rightarrow \{1, 2, 3, \dots\}$ that satisfies

$$T_{i,j} \leq T_{i,j+1} \text{ and } T_{i,j} < T_{i+1,j}, \quad (2.3)$$

where we write $T_{i,j}$ to mean $T((i, j))$. The *weight* of T is the sequence $w(T) = (w_1, w_2, \dots)$, where $w_i = |T^{-1}(i)|$ is the number of times the integer i appears. We denote by SSYT_λ the set of SSYT of shape λ and by $\text{SSYT}(\alpha)$ the set of SSYT of weight α . We define the *skew Schur function* of shape $\lambda = \sigma/\tau$ to be

$$s_\lambda = \sum_{T \in \text{SSYT}_\lambda} \mathbf{x}^T, \quad (2.4)$$

where \mathbf{x}^T is the monomial $x_1^{w_1} x_2^{w_2} \cdots$. When τ is empty, we call s_λ a *Schur function*.

A *multiskew partition* is a finite sequence of skew diagrams $\boldsymbol{\lambda} = (\lambda^{(1)}, \dots, \lambda^{(n)})$. If each $\lambda^{(i)}$ is a row, then we call $\boldsymbol{\lambda}$ a *horizontal-strip*. We denote by

$$\text{SSYT}_\lambda = \{\mathbf{T} = (T^{(1)}, \dots, T^{(n)}) : T^{(i)} \in \text{SSYT}_{\lambda^{(i)}}\} \quad (2.5)$$

the set of *semistandard multiskew tableaux* of shape $\boldsymbol{\lambda}$. Cells $u \in \lambda^{(i)}$ and $v \in \lambda^{(j)}$ with $i < j$ *attack* each other if $c(u) = c(v)$ or $c(u) = c(v) + 1$. The skew shapes $\lambda^{(i)}$ and $\lambda^{(j)}$ *attack* each other if some cells $u \in \lambda^{(i)}$ and $v \in \lambda^{(j)}$ attack each other. Entries $T^{(i)}(u)$ and $T^{(j)}(v)$ with $i < j$ form an *inversion* if either

- $c(u) = c(v)$ and $T^{(i)}(u) > T^{(j)}(v)$, or
- $c(u) = c(v) + 1$ and $T^{(j)}(v) > T^{(i)}(u)$.

We denote by $\text{inv}(\mathbf{T})$ the number of inversions of \mathbf{T} . Now we define the *LLT polynomial*

$$G_\lambda(\mathbf{x}; q) = \sum_{T \in \text{SSYT}_\lambda} q^{\text{inv}(T)} \mathbf{x}^T. \quad (2.6)$$

Example 2.1. Let $\lambda = (4/0, 5/2, 2/0)$. When λ is a horizontal-strip we draw it so that cells of the same content are aligned vertically as on the left. We have written the content in each cell using our convention that content increases from left to right. We have also drawn two tableaux $T, U \in \text{SSYT}_\lambda$ with dotted red lines indicating the inversions.

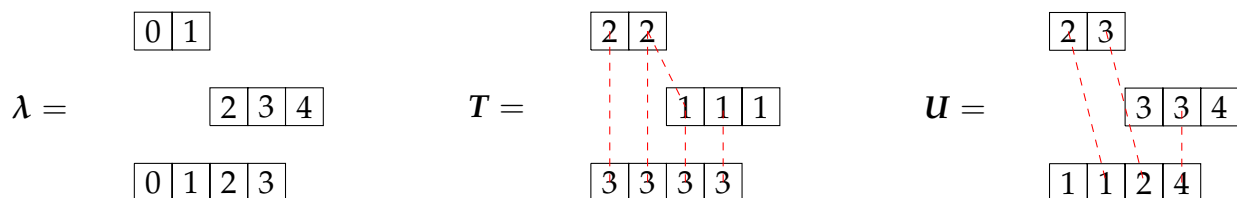

The tableau T contributes $q^5 x_1^3 x_2^2 x_3^4$ to (2.6) and the tableau U contributes $q^3 x_1^2 x_2^2 x_3^3 x_4^2$. We can expand the LLT polynomial $G_\lambda(x; q)$ in the basis of Schur functions as

$$G_\lambda(x; q) = q^5 s_{432} + q^5 s_{441} + q^5 s_{522} + (q^5 + q^4) s_{531} + 2q^4 s_{54} + 2q^4 s_{621} + (q^4 + 2q^3) s_{63} + q^3 s_{711} + (2q^3 + q^2) s_{72} + (q^2 + q) s_{81} + s_9. \quad (2.7)$$

We observe that $G_{(4/0, 5/2, 2/0)}(x; q)$ is *Schur-positive*, meaning that it is an $\mathbb{N}[q]$ -linear combination of Schur functions. In fact, this property holds in general.

Theorem 2.2 ([5, Corollary 6.9]). The LLT polynomial $G_\lambda(x; q)$ is Schur-positive.

The special case where λ is a horizontal-strip was proven in [7, Theorem 3.1.3] using some results introduced in [11]. Both this special case and Theorem 2.2 were proven using Kazhdan–Lusztig theory. It is a major open problem to find an explicit combinatorial Schur-positive expansion of LLT polynomials. We conclude this section with a discussion of a successful solution in a special case.

Theorem 2.3 ([5, Theorem 7.15]). Let $\lambda = (R_1, \dots, R_n)$ be a horizontal-strip such that $\ell(R_1) \leq \dots \leq \ell(R_n)$ and $r(R_1) \geq \dots \geq r(R_n)$ and let $\lambda_i = |R_i|$. Then the LLT polynomial $G_\lambda(x; q)$ is a transformed modified Hall–Littlewood polynomial, whose Schur expansion is known [10] to be

$$G_\lambda(x; q) = \tilde{H}_\lambda(x; q) = \sum_{T \in \text{SSYT}(\lambda)} q^{\text{cocharge}(T)} s_{\text{shape}(T)}, \quad (2.8)$$

where *cocharge* is a combinatorial statistic on tableaux.

We will not fully define *cocharge* here but we will state some of its properties.

1. If T is a single row, then $\text{cocharge}(T) = 0$.

2. If every entry of T is either i or j for some $i < j$, so that

$$T = \begin{array}{|c|c|c|c|c|c|c|c|c|c|c|c|c|c|} \hline j & \cdot & \cdot & \cdot & j & & & & & & & & & \\ \hline i & \cdot & \cdot & \cdot & i & i & \cdot & \cdot & \cdot & i & j & \cdot & \cdot & \cdot & j \\ \hline \end{array},$$

then $\text{cocharge}(T)$ is the number of entries on the second row of T .

3. If $T \in \text{SSYT}_\lambda$ and the i -th row of T is filled with all i 's for every i , then

$$\text{cocharge}(T) = \sum_i (i - 1)\lambda_i.$$

This integer is often denoted $n(\lambda)$.

4. If $T \in \text{SSYT}_\lambda$, then $0 \leq \text{cocharge}(T) \leq n(\lambda)$ with equality only in the cases of (1) and (3).

The central problem of this work is to generalize cocharge in order to prove an analogous combinatorial formula for the Schur expansion of any horizontal-strip LLT polynomial. Our main result, Theorem 4.6, is such a combinatorial formula in the case where no three rows of λ pairwise attack each other. Our strategy is to define a weighted graph $\Pi(\lambda)$ associated to λ and to use it to express linear recurrences of LLT polynomials.

3 A weighted graph description of horizontal-strip LLT polynomials

We begin by defining our weighted graph $\Pi(\lambda)$.

Definition 3.1. Let R and R' be rows. We define the integer

$$M(R, R') = \begin{cases} |R \cap R'| & \text{if } \ell(R) \leq \ell(R'), \\ |R \cap R'^+| & \text{if } \ell(R) > \ell(R'), \end{cases} \quad (3.1)$$

where $R'^+ = \{(1, j + 1) : (1, j) \in R'\}$. Note that $0 \leq M(R, R') \leq \min\{|R|, |R'|\}$.

Definition 3.2. Let $\lambda = (R_1, \dots, R_n)$ be a horizontal-strip. Consider the cells of λ that are the rightmost cells in their row and label these cells $1, \dots, n$ in *content reading order*, meaning in order of increasing content and from bottom to top along constant content lines. We define the *weighted graph* $\Pi(\lambda)$ with vertices v_1, \dots, v_n as follows. The weight of a vertex v_i , denoted $|v_i|$, is the size of the row $R_{i'}$ whose rightmost cell is labelled i . The vertices v_i and v_j with $i < j$ are joined by an edge if the corresponding rows $R_{i'}$ and $R_{j'}$ attack each other and the weight of the edge (v_i, v_j) , denoted $M_{i,j}$, is given by $M(R_{i'}, R_{j'})$. Note that the indexing of the vertices of $\Pi(\lambda)$ may differ from the indexing of the rows of λ .

Example 3.3. Let $\lambda = (R_1, R_2, R_3) = (4/0, 5/2, 2/0)$ as in Example 2.1. We have drawn λ with the rightmost cells in each row labelled in content reading order, and we have drawn $\Pi(\lambda)$ below right. We have $M(R_1, R_2) = 2$, $M(R_1, R_3) = 2$, and $M(R_2, R_3) = 1$.

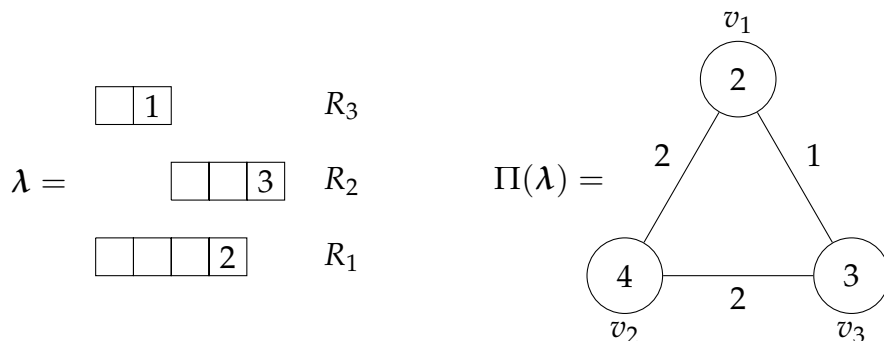

The following Theorem interprets the integer $M(R, R')$ as the maximum number of inversions that any $T \in \text{SSYT}_\lambda$ can have between cells in R and R' .

Theorem 3.4. Let $\lambda = (\lambda^{(1)}, \dots, \lambda^{(n)})$ be a multiskew partition. Define the integer

$$M(\lambda) = \sum_{1 \leq i < j \leq n} \sum_{\substack{R \text{ a row of } \lambda^{(i)} \\ R' \text{ a row of } \lambda^{(j)}}} M(R, R'). \quad (3.2)$$

Then every $T \in \text{SSYT}_\lambda$ has $\text{inv}(T) \leq M(\lambda)$. Moreover, this maximum is attained.

Remark 3.5. Theorem 3.4 tells us that $M(\lambda)$ is the largest power of q in the LLT polynomial $G_\lambda(x; q)$. In particular, if $G_\lambda(x; q) = G_\mu(x; q)$, then $M(\lambda) = M(\mu)$.

We now introduce the language of LLT-equivalence to describe some local linear relations of LLT polynomials. If $\lambda = (\lambda^{(1)}, \dots, \lambda^{(n)})$ and $\mu = (\mu^{(1)}, \dots, \mu^{(n')})$ are multiskew partitions, we denote by $\lambda \cdot \mu$ the concatenation $(\lambda^{(1)}, \dots, \lambda^{(n)}, \mu^{(1)}, \dots, \mu^{(n')})$.

Definition 3.6. Multiskew partitions λ and μ are *LLT-equivalent*, denoted $\lambda \cong \mu$, if for every multiskew partition ν we have the equality of LLT polynomials

$$G_{\lambda \cdot \nu}(x; q) = G_{\mu \cdot \nu}(x; q). \quad (3.3)$$

More generally, we say finite $\mathbb{Q}(q)$ -combinations of multiskew partitions $\sum_i a_i(q) \lambda_i$ and $\sum_j b_j(q) \mu_j$ are *LLT-equivalent*, denoted $\sum_i a_i(q) \lambda_i \cong \sum_j b_j(q) \mu_j$, if for every ν we have

$$\sum_i a_i(q) G_{\lambda_i \cdot \nu}(x; q) = \sum_j b_j(q) G_{\mu_j \cdot \nu}(x; q). \quad (3.4)$$

By finding bijections of tableaux, we prove the following LLT-equivalence relations.

Lemma 3.7. Let R and R' be rows such that $\ell(R') = r(R) + 1$. We have the LLT-equivalence

$$q(R, R') + (R \cup R') \cong q(R \cup R') + (R', R). \quad (3.5)$$

Definition 3.8. We say that two rows R and R' commute if $M(R, R') = M(R', R)$. We write $R \leftrightarrow R'$ if R and R' commute and $R \nleftrightarrow R'$ otherwise.

Lemma 3.9. Let R and R' be rows such that $R \leftrightarrow R'$. We have the LLT-equivalence

$$(R, R') \cong (R', R). \quad (3.6)$$

Remark 3.10. Lemma 3.9 tells us that if $\lambda = (R_1, \dots, R_n)$ and $R_i \leftrightarrow R_{i+1}$, then we can switch rows R_i and R_{i+1} so that $G_\lambda(\mathbf{x}; q) = G_\mu(\mathbf{x}; q)$, where $\mu = (R_1, \dots, R_{i+1}, R_i, \dots, R_n)$. Also note that Theorem 3.4 implies that if $(R, R') \cong (R', R)$, then $R \leftrightarrow R'$.

By repeatedly applying Lemma 3.7 and Lemma 3.9, we are able to prove the following recurrence relation, which is the key tool in our main Theorem.

Lemma 3.11. Let R and R' be rows such that $\ell(R') < \ell(R)$ and $R \nleftrightarrow R'$. We have the LLT-equivalence

$$(R, R') \cong q(R', R) + (1 - q)(R \cup R', R \cap R'). \quad (3.7)$$

We conclude this section by describing the triangle-free weighted graphs $\Pi(\lambda)$ that can arise from a horizontal-strip λ .

Definition 3.12. A graph G is a *caterpillar* if it is a tree and its vertices can be partitioned $V = P \sqcup L$ so that the induced subgraph $G[P]$ is a path and every $v \in L$ has degree one.

Proposition 3.13. Let λ be a horizontal-strip such that $\Pi = \Pi(\lambda)$ is triangle-free.

1. If $i < j < k$ and v_i is adjacent to v_k , then $M_{j,k} = |v_j|$.
2. Every vertex v_i is adjacent to at most one vertex v_j for which $i < j$.
3. Every connected component of Π is a caterpillar $C = (P \sqcup L, E)$ and if $v_j \in L$ is adjacent to v_k , then $M_{j,k} = |v_j|$.
4. If v_i is adjacent to the vertices $\{v_{j_t}\}_{t=1}^r$, then

$$|v_i| + 1 \geq \sum_{t=1}^r M_{i,j_t}. \quad (3.8)$$

Example 3.14. For the horizontal-strip λ below left, we have drawn the caterpillar $\Pi(\lambda)$ below right. We have $P = \{v_1, v_4, v_6\}$ and note that $8 + 1 \geq 3 + 2 + 2 + 2$ and $4 + 1 \geq 2 + 3$.

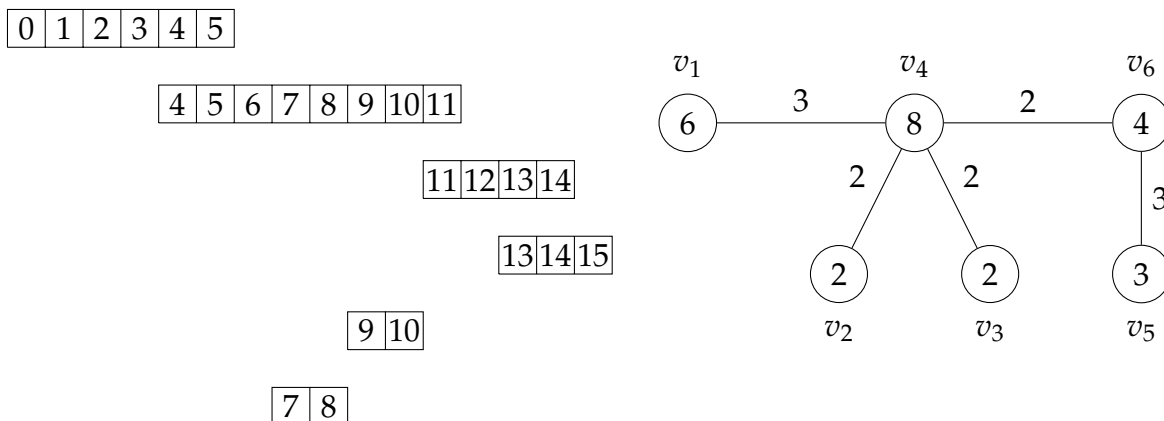

4 The combinatorial formula

In this section we generalize cocharge in order to give a combinatorial formula for the LLT polynomial $G_\lambda(x; q)$ whenever the weighted graph $\Pi(\lambda)$ is triangle-free.

Definition 4.1. Let μ be a partition and let $T \in \text{SSYT}_\mu$ be a tableau of shape μ with smallest entry i . We define the integer

$$f(T) = \max\{t : 0 \leq t \leq \mu_1 - \mu_2, t \leq w_i(T), T_{2,j'} > T_{1,j'+t} \text{ for all } 1 \leq j' \leq \mu_2\}, \quad (4.1)$$

where $w_i(T)$ is the number of i 's in T .

Remark 4.2. Informally, $f(T)$ is the maximum number of i 's that we can remove from T so that no entry moves down when we rectify the resulting skew tableau. Alternatively, $f(T)$ is the maximum number of cells that we can shift the bottom row of T to the left and still have the columns strictly increasing from bottom to top, as long as $f(T) \leq w_i(T)$.

Definition 4.3. Let T be an SSYT and let $i < j$ be integers. We denote by $T|_{i,j}$ the rectification of the skew tableau obtained by restricting T to the entries x with $i \leq x \leq j$, and we define the integer

$$\text{cocharge}_{i,j}(T) = w_i(T) - f(T|_{i,j}). \quad (4.2)$$

Example 4.4. For the tableaux S and T below left, we have drawn the tableaux $S|_{2,4}$ and $T|_{2,4}$ below right. We have $f(S|_{2,4}) = 3$ and $\text{cocharge}_{2,4}(S) = 5 - 3 = 2$, and we have

$f(T|_{2,4}) = 3$ because we must have $t \leq w_2(T|_{2,4})$, so $\text{cocharge}_{2,4}(T) = 3 - 3 = 0$.

$$\begin{array}{c}
 S = \begin{array}{|c|c|c|c|c|c|} \hline 3 & 4 & & & & \\ \hline 2 & 2 & 3 & 4 & 5 & 5 \\ \hline 1 & 1 & 1 & 2 & 2 & 2 & 3 & 4 \\ \hline \end{array}
 \end{array}
 \quad
 \begin{array}{c}
 S|_{2,4} = \begin{array}{|c|c|c|c|c|c|} \hline 4 & & & & & \\ \hline 3 & 3 & 4 & & & \\ \hline 2 & 2 & 2 & 2 & 2 & 3 & 4 \\ \hline \end{array}
 \end{array}$$

$$\begin{array}{c}
 T = \begin{array}{|c|c|c|c|c|c|} \hline 4 & 5 & & & & \\ \hline 2 & 2 & 4 & 4 & 5 & 5 \\ \hline 1 & 1 & 1 & 2 & 3 & 3 & 3 & 3 \\ \hline \end{array}
 \end{array}
 \quad
 \begin{array}{c}
 T|_{2,4} = \begin{array}{|c|c|c|c|c|c|} \hline 4 & 4 & 4 & & & \\ \hline 2 & 2 & 2 & 3 & 3 & 3 & 3 \\ \hline \end{array}
 \end{array}$$

Example 4.5. In the case where $j = i + 1$, $\text{cocharge}_{i,i+1}(T)$ is the number of entries in the second row of $T|_{i,i+1}$, which agrees with $\text{cocharge}(T|_{i,i+1})$.

We now state our main Theorem.

Theorem 4.6. Let λ be a horizontal-strip such that the weighted graph $\Pi = \Pi(\lambda)$ is triangle-free and let $\alpha_i = |v_i|$. Then the LLT polynomial of λ is

$$G_\lambda(\mathbf{x}; q) = \sum_{T \in \text{SSYT}(\alpha)} q^{\text{cocharge}_\Pi(T)} s_{\text{shape}(T)}, \tag{4.3}$$

where $\text{cocharge}_\Pi(T) = \sum_{i < j} \min\{M_{i,j}, \text{cocharge}_{i,j}(T)\}$.

Example 4.7. Let $\lambda = (6/5, 9/6, 7/2, 4/0)$ be the horizontal-strip below left with the rightmost cells in each row labelled in content reading order, so that $\Pi(\lambda)$ is the caterpillar below right.

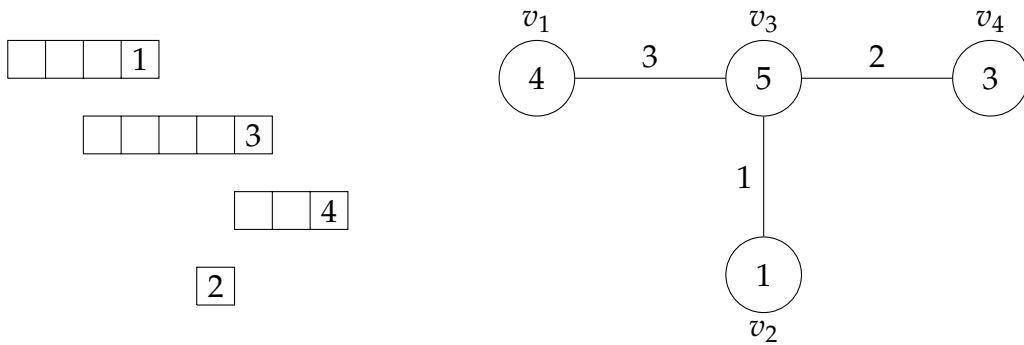

To calculate the coefficient of s_{733} , we consider the three tableaux of weight $\alpha = 4153$ and shape 733 as follows. The values of cocharge_Π are calculated below.

$$\begin{array}{c}
 T = \begin{array}{|c|c|c|c|c|c|} \hline 4 & 4 & 4 & & & \\ \hline 3 & 3 & 3 & & & \\ \hline 1 & 1 & 1 & 1 & 2 & 3 & 3 \\ \hline \end{array}
 \end{array}
 \quad
 \begin{array}{c}
 T_1 = \begin{array}{|c|c|c|c|c|c|} \hline 4 & 4 & 4 & & & \\ \hline 2 & 3 & 3 & & & \\ \hline 1 & 1 & 1 & 1 & 3 & 3 & 3 \\ \hline \end{array}
 \end{array}
 \quad
 \begin{array}{c}
 T_2 = \begin{array}{|c|c|c|c|c|c|} \hline 3 & 4 & 4 & & & \\ \hline 2 & 3 & 3 & & & \\ \hline 1 & 1 & 1 & 1 & 3 & 3 & 4 \\ \hline \end{array}
 \end{array}$$

$$\begin{array}{c}
 2 + 1 + 2 = 5
 \end{array}
 \quad
 \begin{array}{c}
 3 + 0 + 2 = 5
 \end{array}
 \quad
 \begin{array}{c}
 3 + 1 + 2 = 6
 \end{array}$$

Therefore, the coefficient of s_{733} is $(q^6 + 2q^5)$.

Corollary 4.8. Let λ be a horizontal-strip whose weighted graph $\Pi(\lambda)$ is the path below.

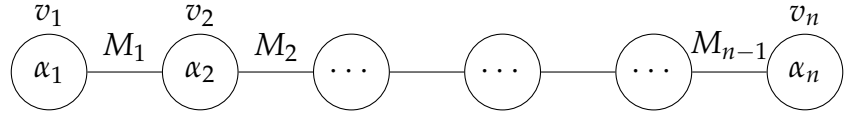

Then the LLT polynomial of λ is

$$G_\lambda(\mathbf{x}; q) = \sum_{T \in \text{SSYT}(\alpha)} q^{\text{cocharge}_\Pi(T)} s_{\text{shape}(T)}, \tag{4.4}$$

where $\text{cocharge}_\Pi(T) = \sum_{i=1}^{n-1} \min\{M_i, \text{number of entries in the second row of } T|_{i,i+1}\}$.

Example 4.9. Let λ be a horizontal-strip with exactly two rows, so that $\Pi(\lambda)$ is

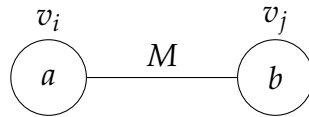

for some $a \geq b \geq M$, where (i, j) is either $(1, 2)$ or $(2, 1)$, so $\alpha = (a, b)$ or $\alpha = (b, a)$ respectively. In either case, for each $0 \leq k \leq b$, there is a unique tableau T_k with content α and shape $(a + b - k)k$. Therefore, by Corollary 4.8, the LLT polynomial is

$$G_\lambda(\mathbf{x}; q) = \sum_{k=0}^b q^{\min\{M, k\}} s_{(a+b-k)k} = s_{(a+b)} + \dots + q^M s_{(a+b-M)M} + \dots + q^M s_{ab}. \tag{4.5}$$

Note that in this example, the formula (4.3) does not depend on the labelling of Π .

The full proof of Theorem 4.6 appears in an upcoming paper. For now, we will illustrate the idea of the proof in the case of Example 4.7.

We will use induction on $M(\lambda)$. By applying Lemma 3.11 to rows R_3 and R_4 , we can write

$$G_\lambda(\mathbf{x}; q) = qG_{\lambda'}(\mathbf{x}; q) + (1 - q)G_{\lambda''}(\mathbf{x}; q), \tag{4.6}$$

where the weighted graphs $\Pi = \Pi(\lambda)$, $\Pi' = \Pi(\lambda')$, and $\Pi'' = \Pi(\lambda'')$ are given below.

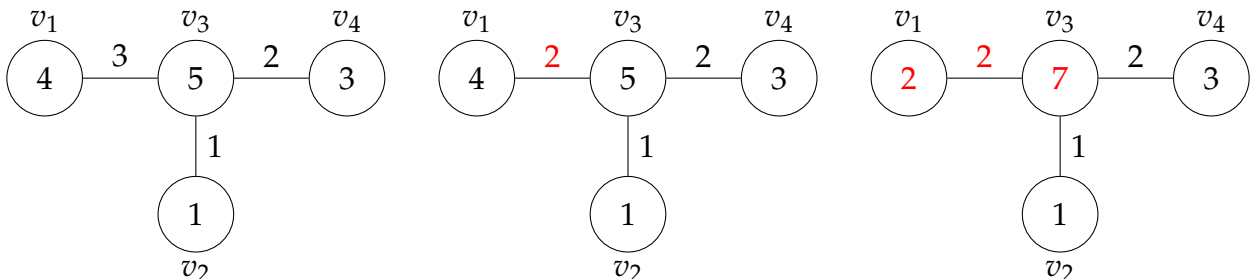

By our induction hypothesis, our task is now to prove that

$$\sum_{T \in \text{SSYT}(4153)} q^{\text{cocharge}_{\Pi}(T)} s_{\text{shape}(T)} = q \sum_{T \in \text{SSYT}(4153)} q^{\text{cocharge}_{\Pi'}(T)} s_{\text{shape}(T)} + (1 - q) \sum_{S \in \text{SSYT}(2173)} q^{\text{cocharge}_{\Pi''}(S)} s_{\text{shape}(S)}. \quad (4.7)$$

Let us consider the coefficient of s_{733} . The first sum on the right hand side corresponds to the three tableaux from Example 4.7 below.

$$T = \begin{array}{|c|c|c|} \hline 4 & 4 & 4 \\ \hline 3 & 3 & 3 \\ \hline 1 & 1 & 1 \\ \hline \end{array} \begin{array}{|c|c|c|c|c|c|} \hline & & & 1 & 2 & 3 & 3 \\ \hline \end{array} \quad T_1 = \begin{array}{|c|c|c|} \hline 4 & 4 & 4 \\ \hline 2 & 3 & 3 \\ \hline 1 & 1 & 1 \\ \hline \end{array} \begin{array}{|c|c|c|c|c|c|} \hline & & & 1 & 3 & 3 & 3 \\ \hline \end{array} \quad T_2 = \begin{array}{|c|c|c|} \hline 3 & 4 & 4 \\ \hline 2 & 3 & 3 \\ \hline 1 & 1 & 1 \\ \hline \end{array} \begin{array}{|c|c|c|c|c|c|} \hline & & & 1 & 3 & 3 & 4 \\ \hline \end{array}$$

$2 + 1 + 2 = 5$ $2 + 0 + 2 = 4$ $2 + 1 + 2 = 5$

The factor of q tells us to increase these values by one, and this corresponds to increasing $M_{1,3}$ from 2 to 3. Indeed, for the tableaux T_1 and T_2 , because $\text{cocharge}_{1,3}(T_i) = 3$, the contribution to $\text{cocharge}_{\Pi}(T_i)$ is now $\min\{3, 3\} = 3$ instead of $\min\{2, 3\} = 2$. However, the tableau T has $\text{cocharge}_{1,3}(T) = 2$, so in this case we do not want to increase the cocharge by one. The second sum allows us to make this correction. It corresponds to the tableau below.

$$S = \begin{array}{|c|c|c|} \hline 4 & 4 & 4 \\ \hline 3 & 3 & 3 \\ \hline 1 & 1 & 2 \\ \hline \end{array} \begin{array}{|c|c|c|c|c|c|} \hline & & & 3 & 3 & 3 & 3 \\ \hline \end{array}$$

$2 + 1 + 2 = 5$

The factor of $(1 - q)$ tells us to change the term $q^6 s_{733}$ corresponding to T back into the term $q^5 s_{733}$. In general, this second sum precisely corrects for those tableaux for which we do not want to increase the cocharge by one when we change $M_{1,3}$. To be more precise, (4.7) will follow from a bijection

$$\varphi : \text{SSYT}(2173) \rightarrow \{T \in \text{SSYT}(4153) : \text{cocharge}_{1,3}(T) \leq 2\} \quad (4.8)$$

such that $\text{cocharge}_{\Pi''}(S) = \text{cocharge}_{\Pi'}(\varphi(S))$.

Theorem 4.6 expresses the LLT polynomial $G_{\lambda}(x; q)$ in terms of the weighted graph $\Pi(\lambda)$ but not in terms of λ itself. In other words, if $\Pi(\lambda)$ and $\Pi(\mu)$ are equal and triangle-free, then $G_{\lambda}(x; q) = G_{\mu}(x; q)$. We conjecture that the formula (4.3) does not depend on the labelling of the vertices of $\Pi(\lambda)$, provided that whenever $i < j < k$ and v_i is adjacent to v_k , then $M_{j,k} = |v_j|$. By Proposition 3.13, Part 5, this is equivalent to the following statement.

Conjecture 4.10. Let λ and μ be horizontal-strips. If the weighted graphs $\Pi(\lambda)$ and $\Pi(\mu)$ are isomorphic and triangle-free, then the LLT polynomials $G_\lambda(x; q)$ and $G_\mu(x; q)$ are equal.

We further conjecture that in general a horizontal-strip LLT polynomial $G_\lambda(x; q)$ is determined by its unlabelled weighted graph.

Conjecture 4.11. Let λ and μ be horizontal-strips. If the weighted graphs $\Pi(\lambda)$ and $\Pi(\mu)$ are isomorphic, then the LLT polynomials $G_\lambda(x; q)$ and $G_\mu(x; q)$ are equal.

References

- [1] P. Alexandersson. “LLT polynomials, elementary symmetric functions and melting lollipops”. *J. Algebraic Combin.* (2020).
- [2] P. Alexandersson and R. Sulzgruber. “A combinatorial expansion of vertical-strip LLT polynomials in the basis of elementary symmetric functions” (2020). [arXiv:2004.09198](#).
- [3] P. Alexandersson and J. Uhlin. “Cyclic sieving, skew Macdonald polynomials and Schur positivity” (2019). [arXiv:1908.00083](#).
- [4] M. D’Adderio. “e-Positivity of vertical strip LLT polynomials” (2019). [arXiv:1906.02633](#).
- [5] I. Grojnowski and M. Haiman. “Affine Hecke algebras and positivity of LLT and Macdonald polynomials” (2007).
- [6] J. Haglund, M. Haiman, and N. Loehr. “A combinatorial formula for Macdonald polynomials”. *J. Amer. Math. Soc.* **18** (2005), pp. 735–761.
- [7] J. Haglund, M. Haiman, N. Loehr, J. Remmel, and A. Ulyanov. “A combinatorial formula for the character of the diagonal coinvariants”. *Duke Math. J.* **126** (2005), pp. 195–232.
- [8] J. Huh, S. Nam, and M. Yoo. “Melting lollipop chromatic quasisymmetric functions and Schur expansion of unicellular LLT polynomials” (2018). [arXiv:1812.03445](#).
- [9] A. Lascoux, B. Leclerc, and J.-Y. Thibon. “Ribbon tableaux, Hall–Littlewood functions, quantum affine algebras, and unipotent varieties”. *J. Math. Phys.* **38** (1997), pp. 1041–1068.
- [10] A. Lascoux and M.-P. Schützenberger. “Sur une conjecture de H. O. Foulkes”. *C. R. Acad. Sci.* **286** (1978).
- [11] B. Leclerc and J.-Y. Thibon. “Littlewood–Richardson coefficients and Kazhdan–Lusztig polynomials”. *Adv. Stud. Pure Math.* **28** (2000), pp. 155–220.